

Through-penetration Firestop Systems

System No. F-A-2336

ANSI/UL1479 (ASTM E814)	CAN / ULC S115
F Rating — 3 Hr	F Rating – 3 Hr
T Rating — 3 Hr	FT Rating – 3 Hr
	FH Rating – 3 Hr
	FTH Rating – 3 Hr

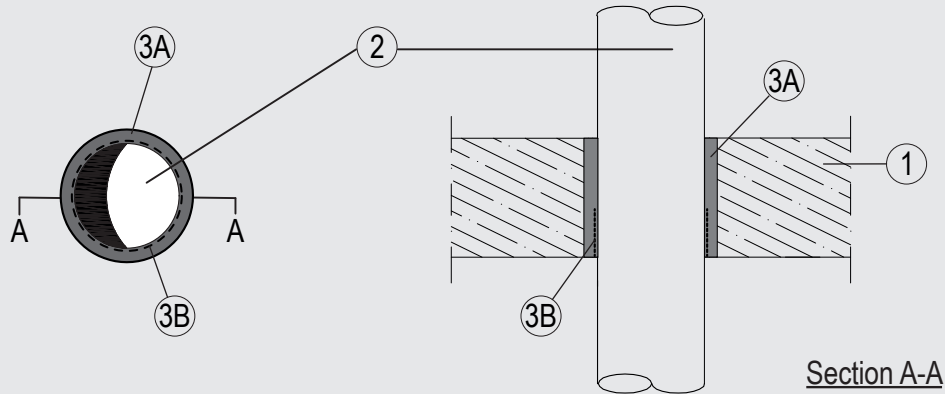

System tested with a pressure differential of 2.5 Pa between the exposed and the unexposed surfaces with the higher pressure on the exposed side.

1. Floor Assembly

Min. 4-1/2 in. (115 mm) thick lightweight or normal weight (100-150 pcf or 1600 - 2400 kg/m³) concrete. Opening shall be circular or rectangular with max diameter or dimensions of 6.3 in. (160 mm).

2. Pipes / Tubes

Single to be installed within the opening. The annular space between the pipes and the periphery of the opening to be 1 in (25 mm). Pipes to be rigidly supported on both sides of the floor assembly. The following penetrants may be used:

- A. Nom 4.3 in (110 mm) diam 0.25 in (6.3 mm) wall thickness PP pipe for use in closed (process or supply) piping systems.

3. Firestop System

The Firestop System shall consist of the following:

- A. Packing Material — UL Certified gypsum mud, minimum 1 in. width inside the aperture.
- B. Fill, Void or Cavity Material* — 1 length of 1 layer of 1/16 in (1.5 mm) by 2 in. (50 mm) wrap flush mounted on the exposed side around the pipe.
SVT BRANDSCHUTZ VERTRIEBSGESELLSCHAFT MBH INTERNATIONAL — PYRO-SAFE DG-CR BS

*Indicates such products shall bear the UL or cUL Certification Mark for jurisdictions employing the UL or cUL Certification (such as Canada), respectively.

Please contact us for further information:
 Information: global@svt.de Order: order@svt.de
 +49 4105-40 90-0